

data sheet:

FILCOTEN pro green NW400

Rinne / Channel:

FILCOTEN pro NW400 30-0 G

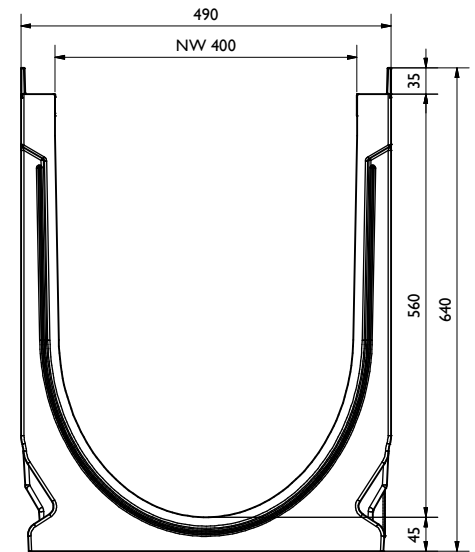
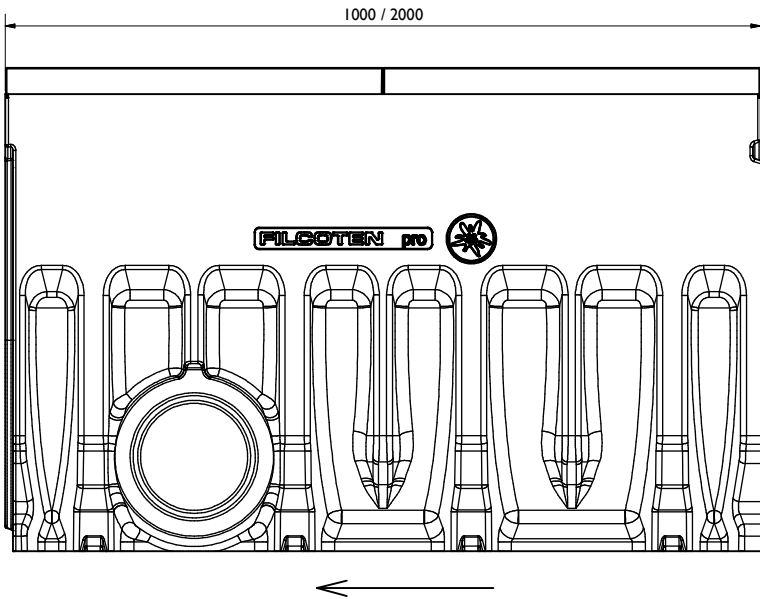

Filtereinheiten / filter units:

19540950, ~115kg/m : bestehend aus/consisting off:

19540910 Vorfiltermatte Länge 5000mm, Breite 500mm
prefiltermat lenght 5000mm, width 500mm

19500900-19500904: Filtermaterial / filter-material ViaSorp Big Bag
Big Bag Größe / size: I; 0,85; 0,5 und 0,25m³

19040360 Trapez-Lochblech aus Edelstahl Länge 2000mm/1000mm

19040361 trapezoidal perforated sheet metal lenght 2000mm/1000mm
made out of stainless steel

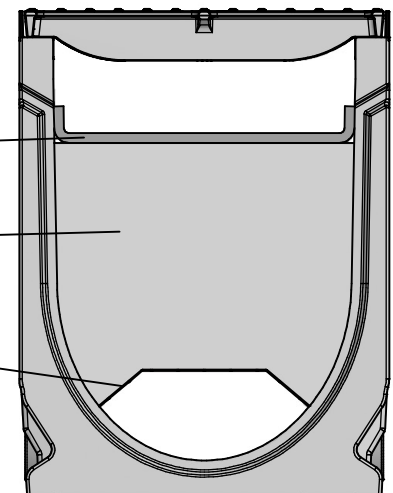

Rinne / channel - Maße / dimensions [mm]					
Typ	Höhe A height A	Höhe B height B	Länge length	BG code G	Gewicht weight G [kg]
30-0	640	640	2000	10640166	287
30-0	640	640	1000	10641166	145

Legende / explanation:	
V:	verzinkter Stahl / galvanized steel
E:	Edelstahl / stainless steel
G:	Gußeisen / ductil iron
H:	Holz / wood

data sheet:

FILCOTEN pro green NW400



Gußrost / Ductile iron grating:

BG code: GJS 17040181; 34,5kg; E600kN SW18/220

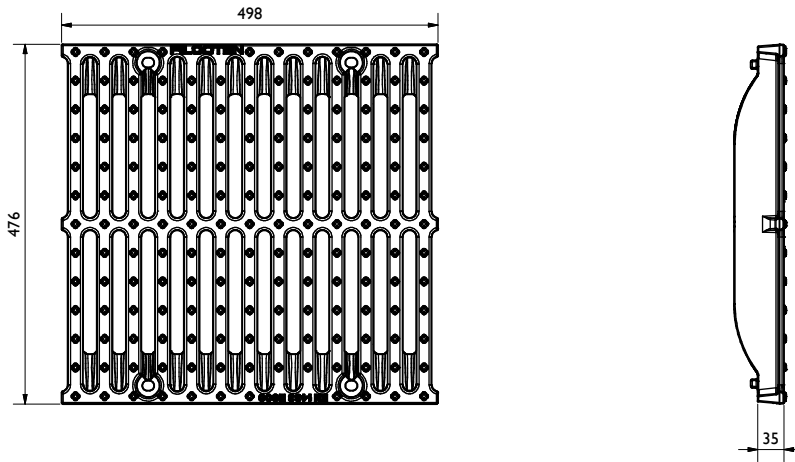

data sheet:

FILCOTEN pro green NW400

Stirn-/ Endplatte / front- / end-cap:

BG code: E 19040350; 4,5kg

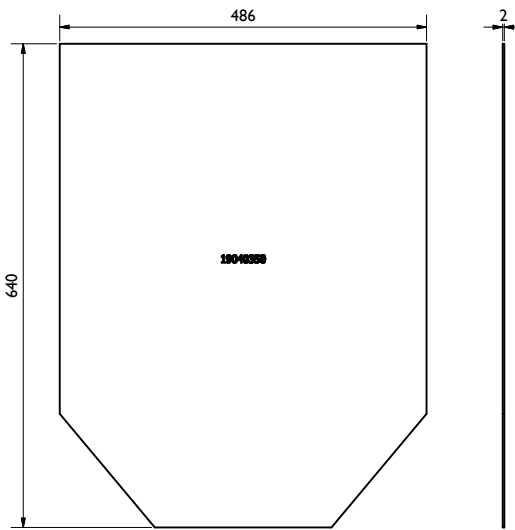

BG code: E 19040351; 5,5kg

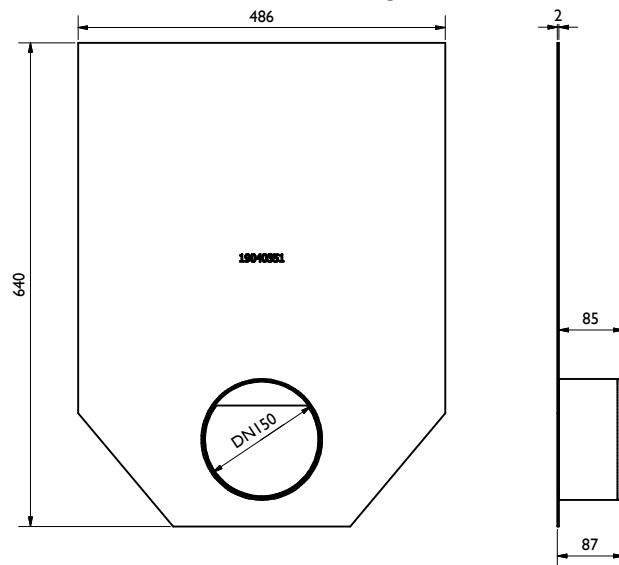

Schottblech / partition sheet:

BG code: E 19040353; 2kg

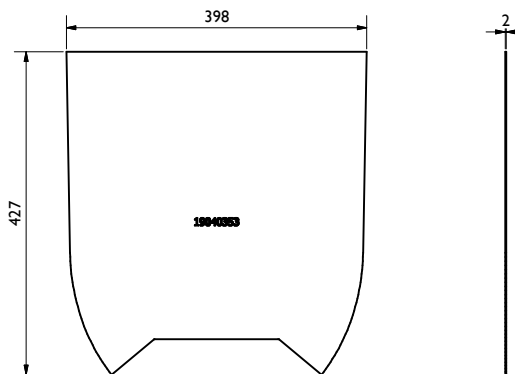

Verschraubungsmaterial / Bolting material:

BG code: V 32110, E 32122
(Gussrost / Ductile iron grating)



Werkzeug zum Filtermaterial Glätten / tool for substrat flattening :

BG code: H 19040500, 1kg

